

Kábelszerkezetek



Különleges tartószerkezetek

Szerkezeti elemek: kábelek

- kötelek:
növényi
- kábelek:
acél, műanyag
sodrott szerkezet
- csak húzást képes felvenni

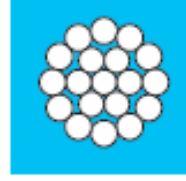
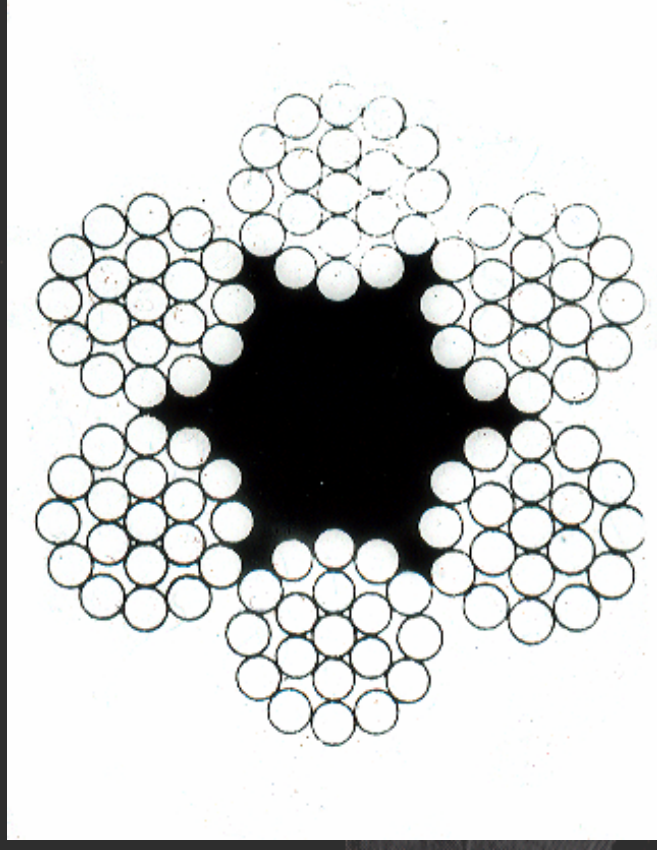

1 x 19

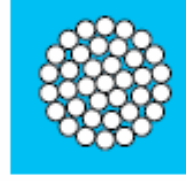

1 x 37

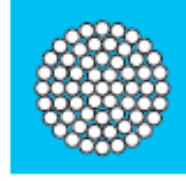

1 x 61



WWS-1



WWS-2



WWS-3

Szerkezeti elemek: kábel kapcsolatok

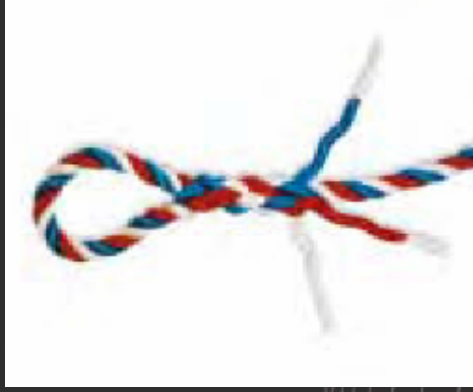

Szerkezeti elemek: kábel kapcsolatok



Szerkezeti elemek: kapcsoló elemek

Kötélszív



Szorítóbilincs



Hüvelyek



Sekli



Gyűrűs csavar



Feszítőcsavar



Szerkezeti elemek: kábel kapcsolatok

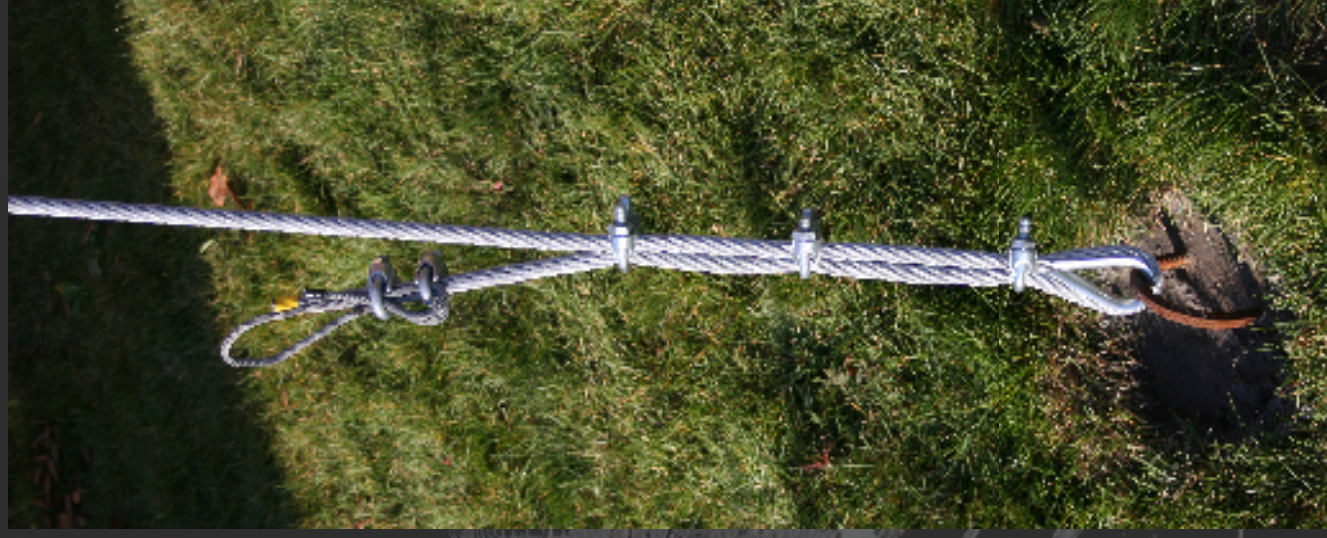
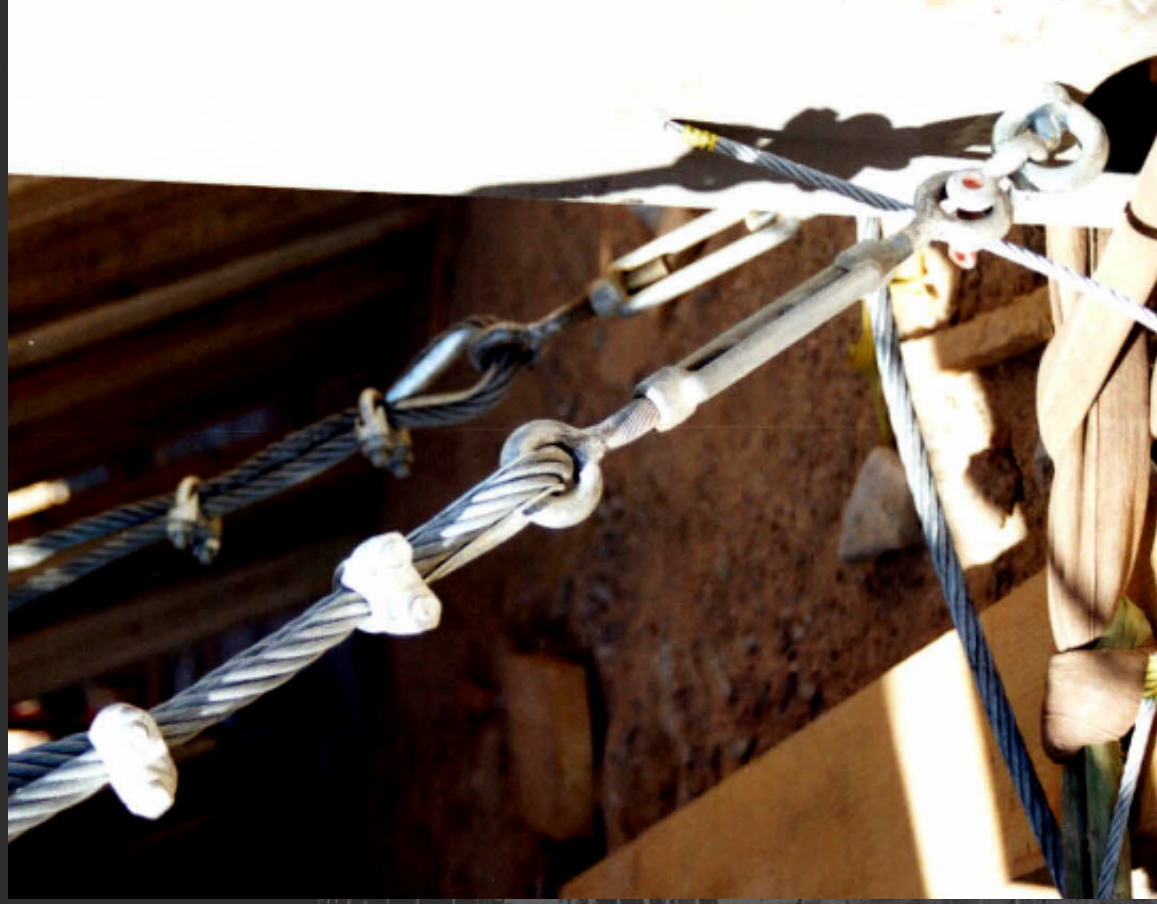

Szerkezeti elemek: kábel kapcsolatok

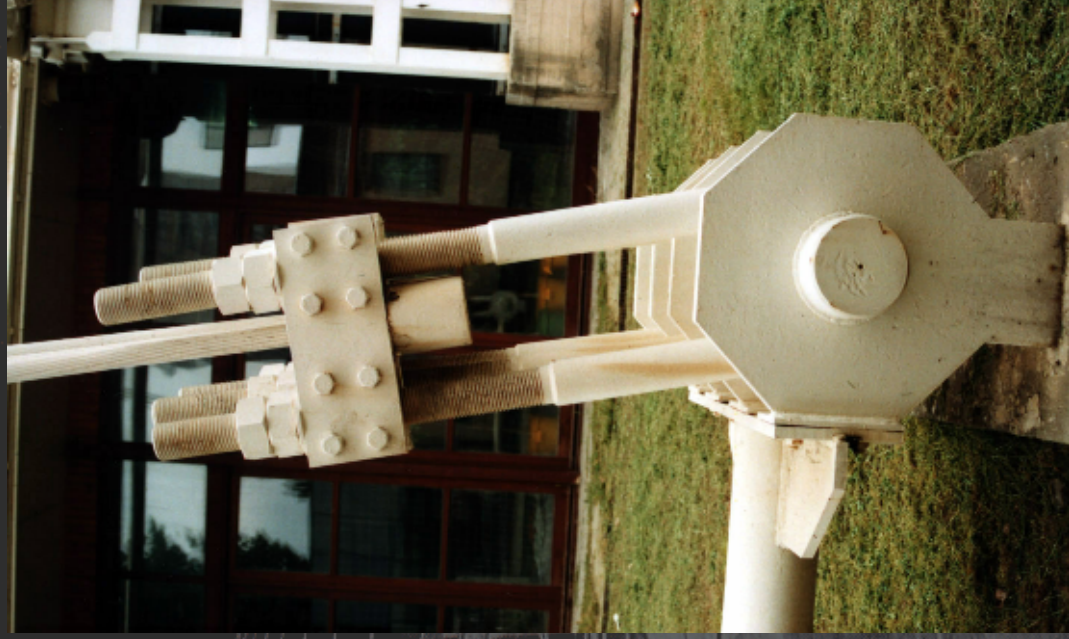

Szerkezeti elemek: kábel kapcsolatok

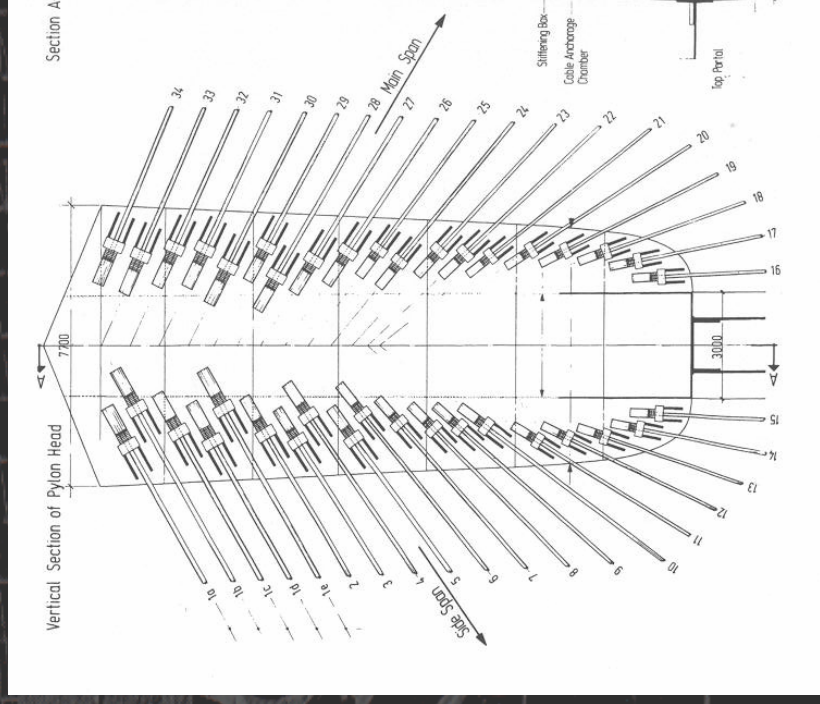

Szerkezeti elemek: kábel kapcsolatok

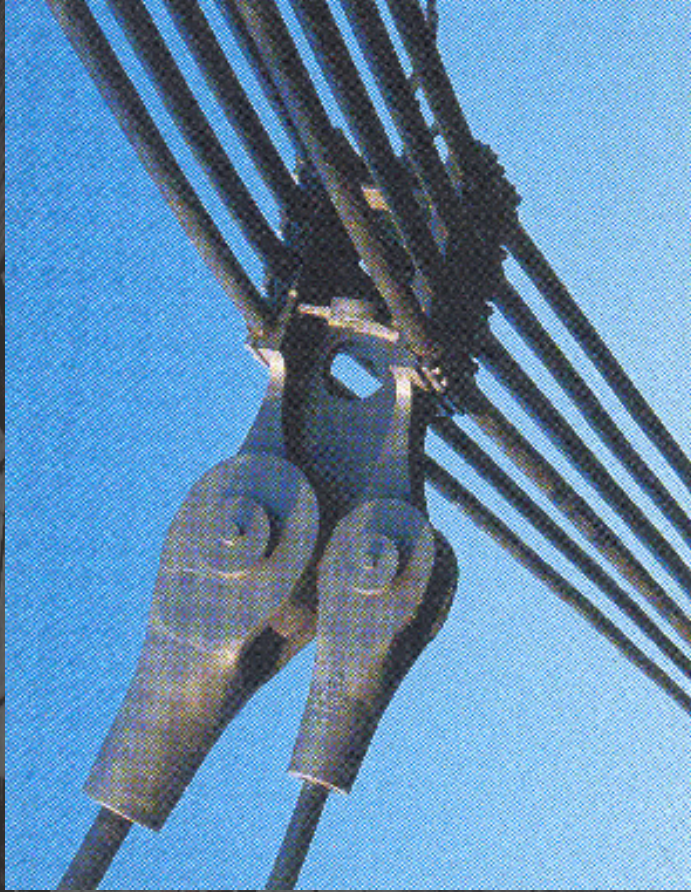
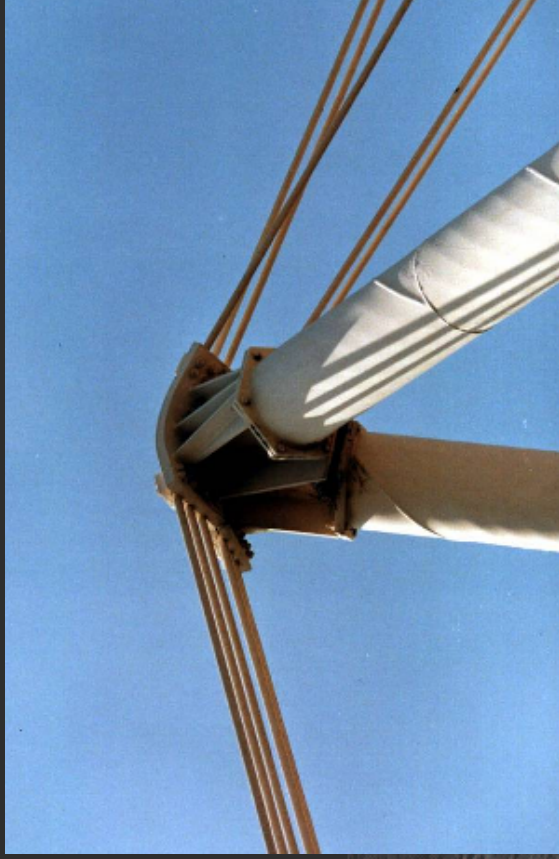

Szerkezeti elemek: kábel kapcsolatok

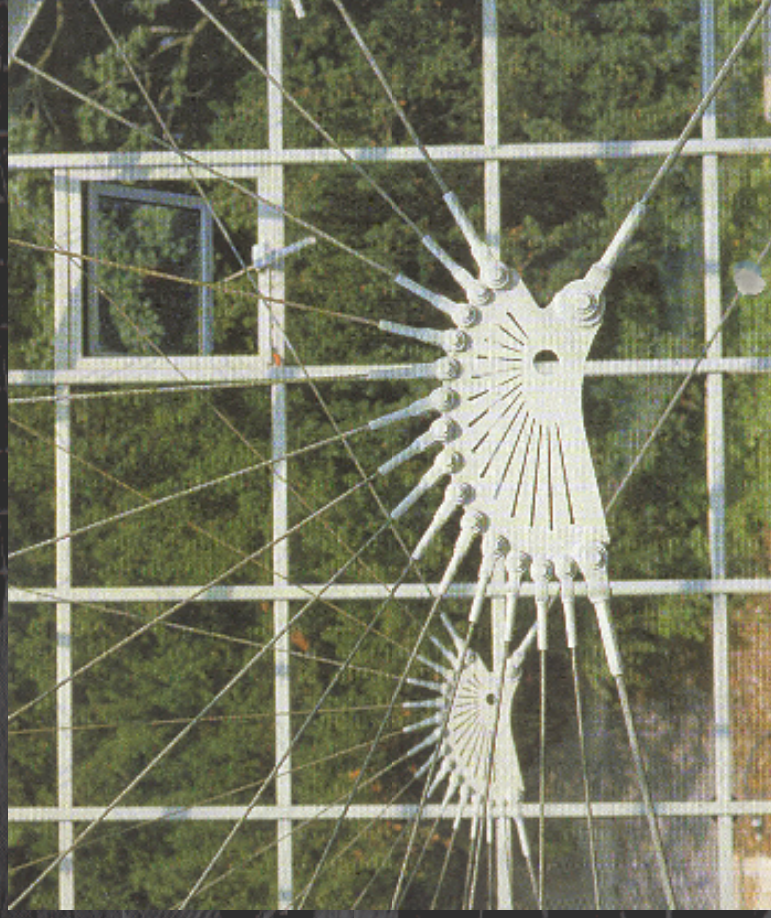
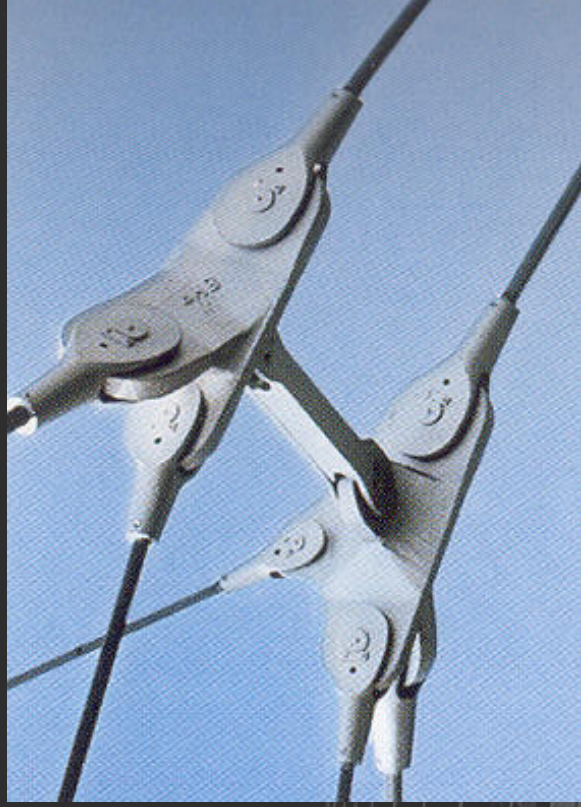

Szerkezeti elemek: kábel kapcsolatok

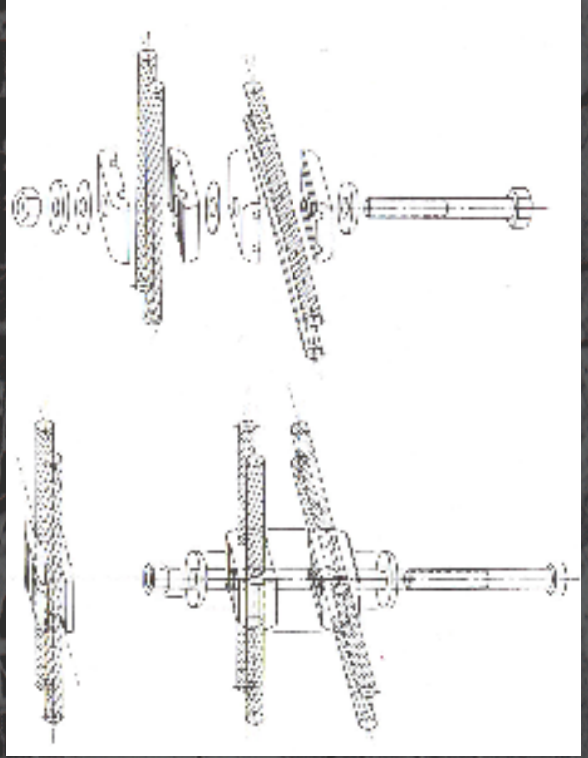
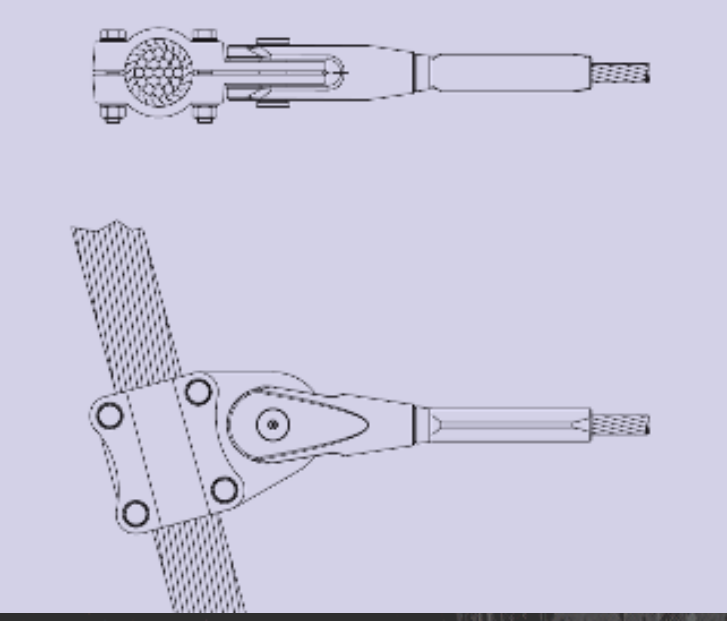

Szerkezeti elemek: kábel kapcsolatok

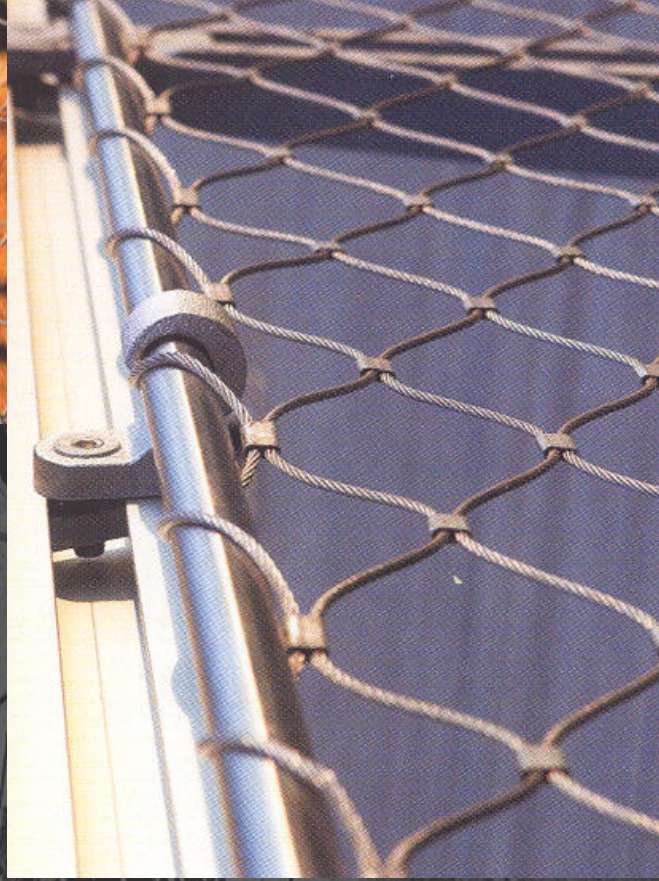

Alaktartás

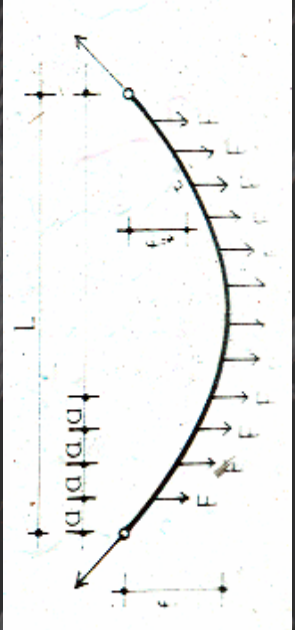
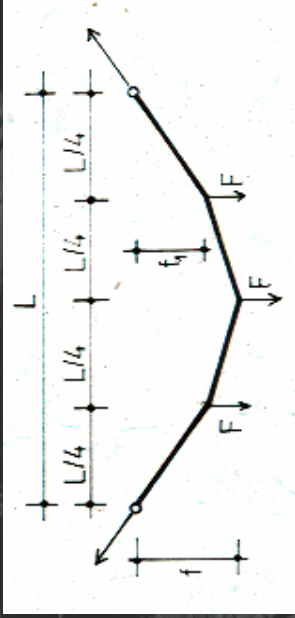
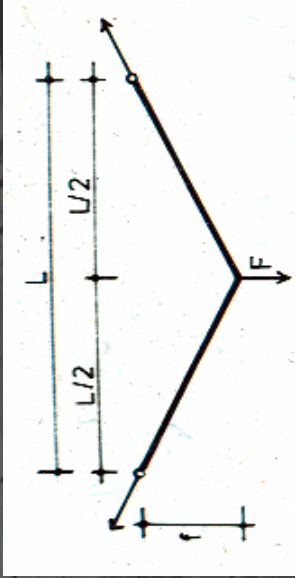
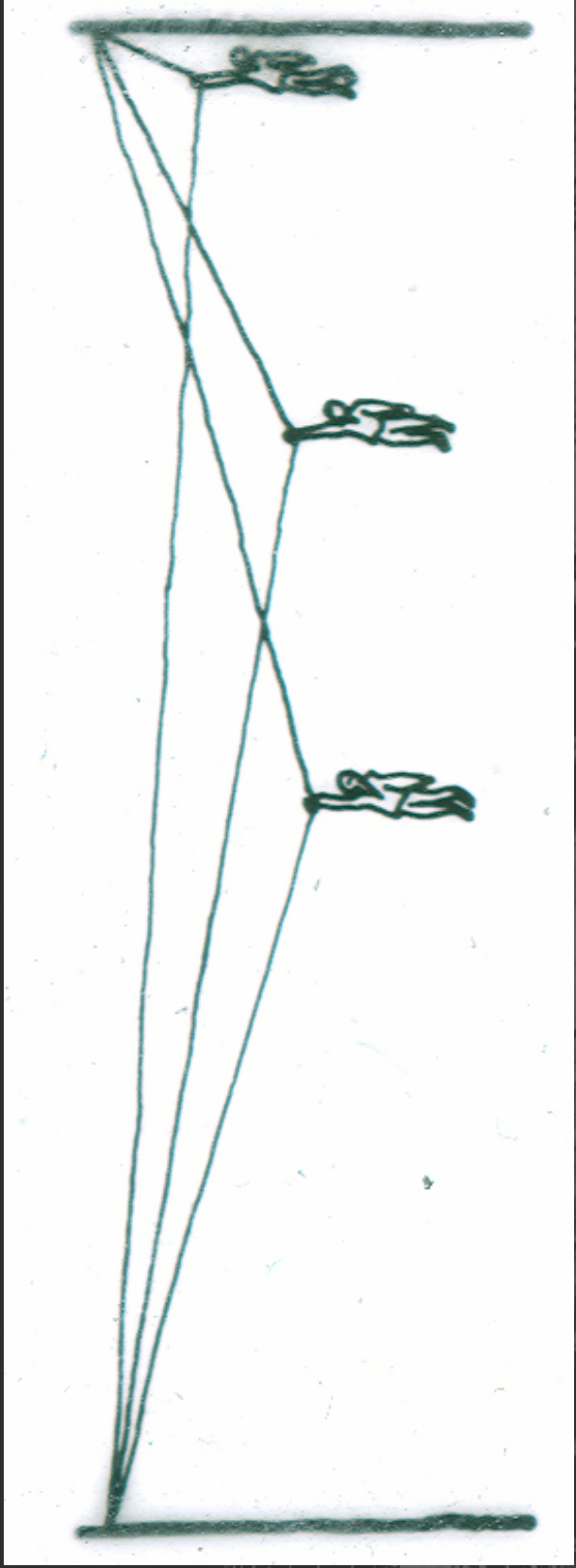

Alaktartás

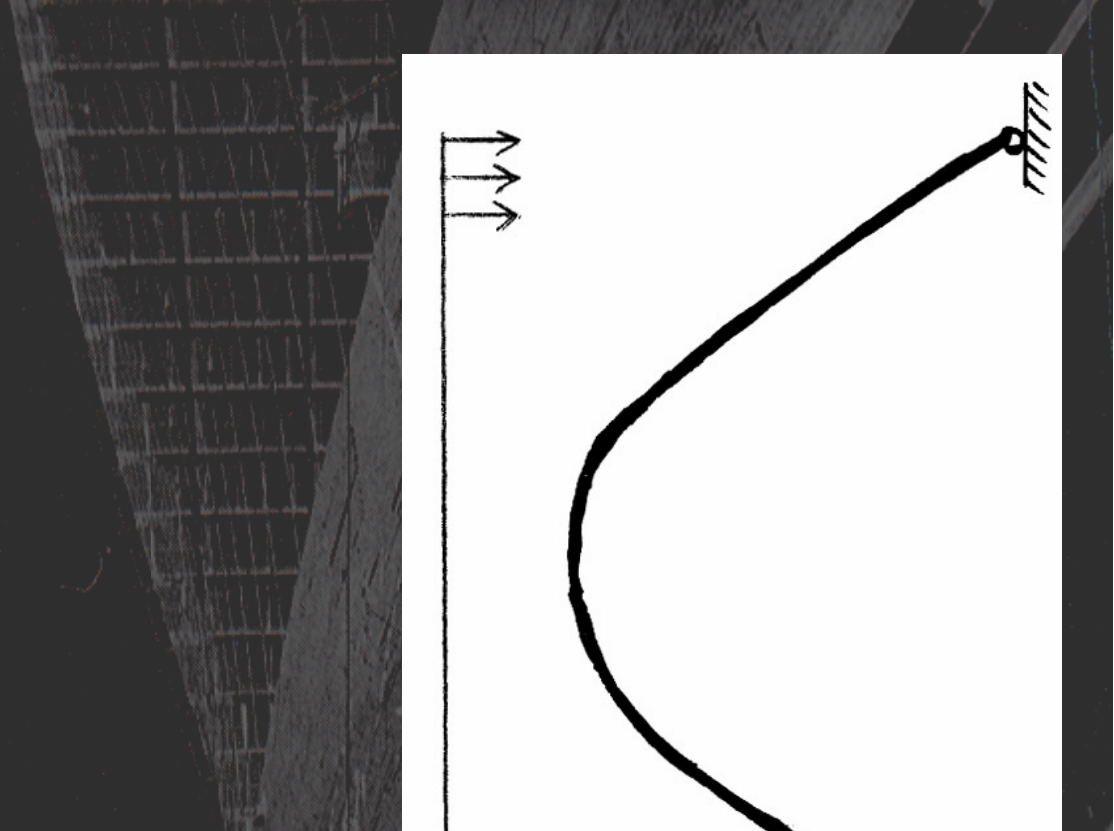
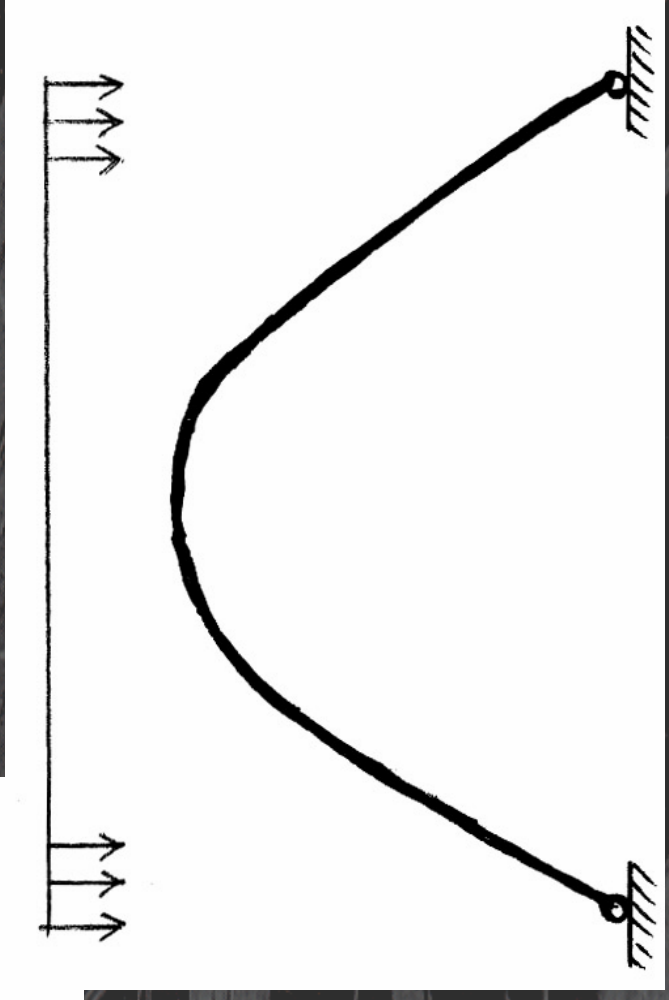
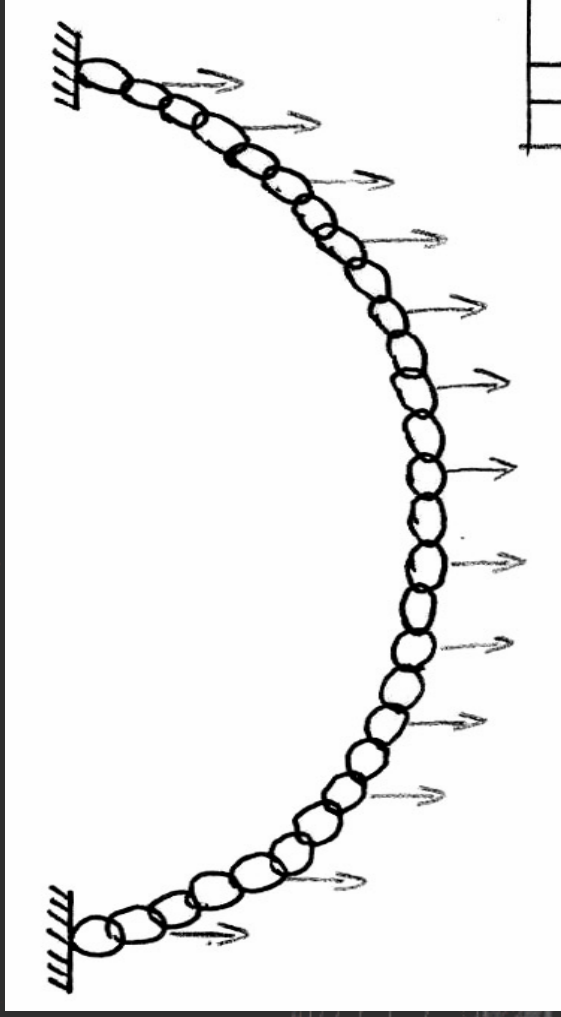

Alaktartás

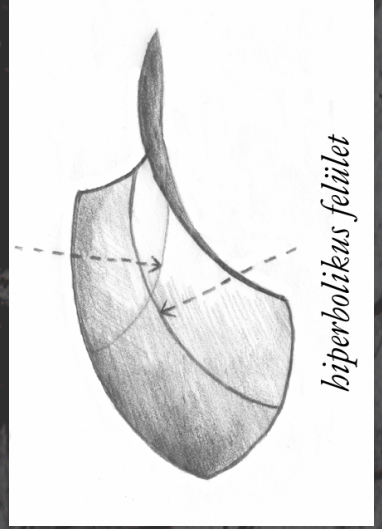
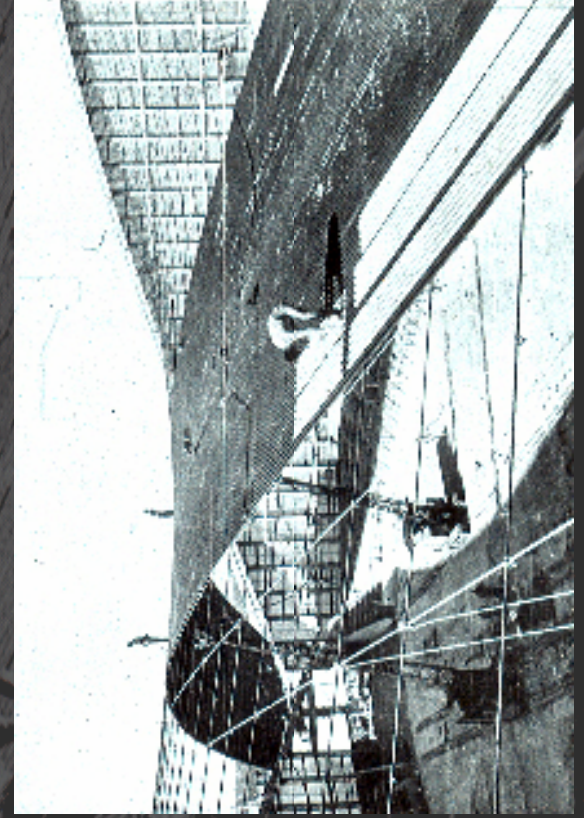
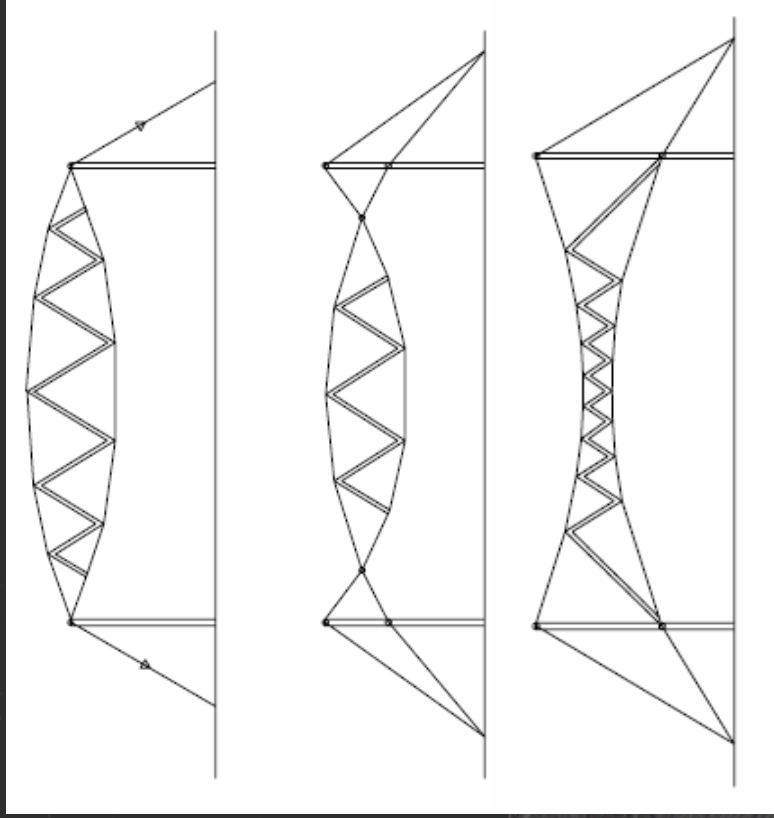
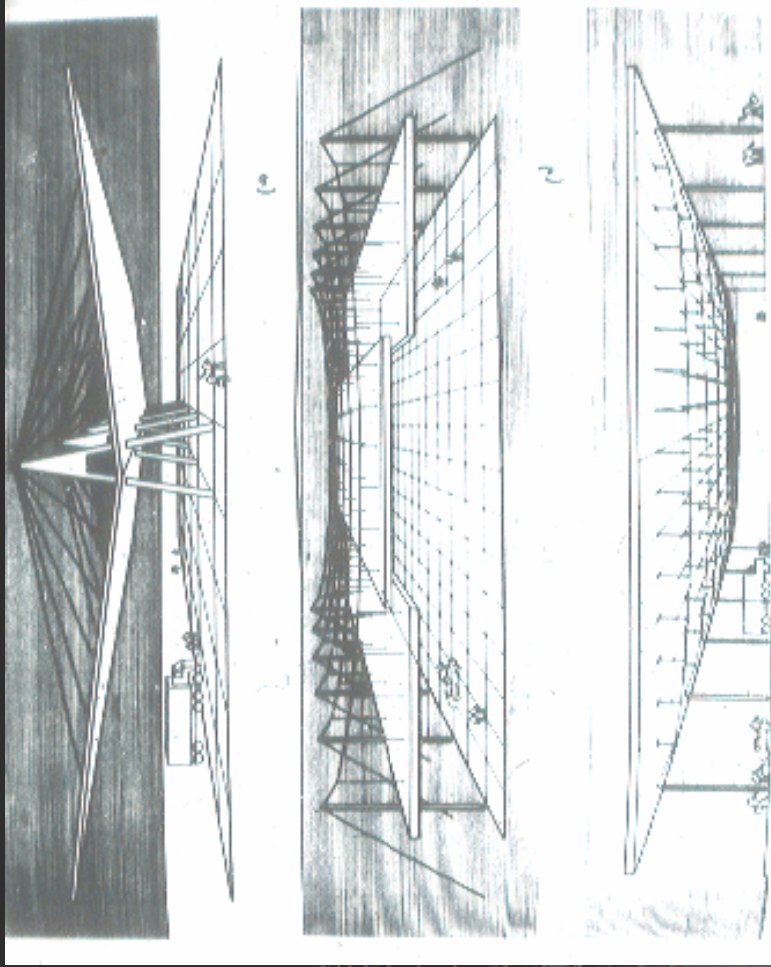

Támaszok kialakítása

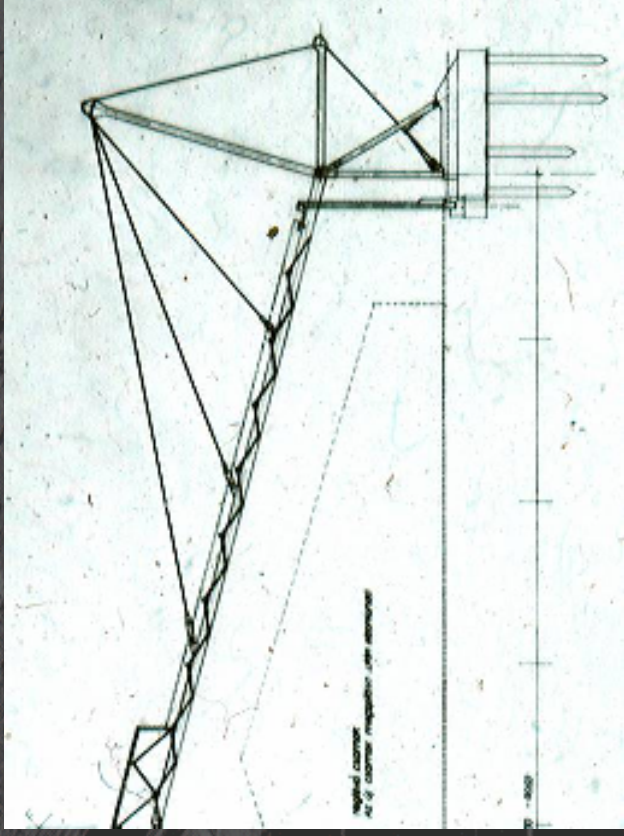
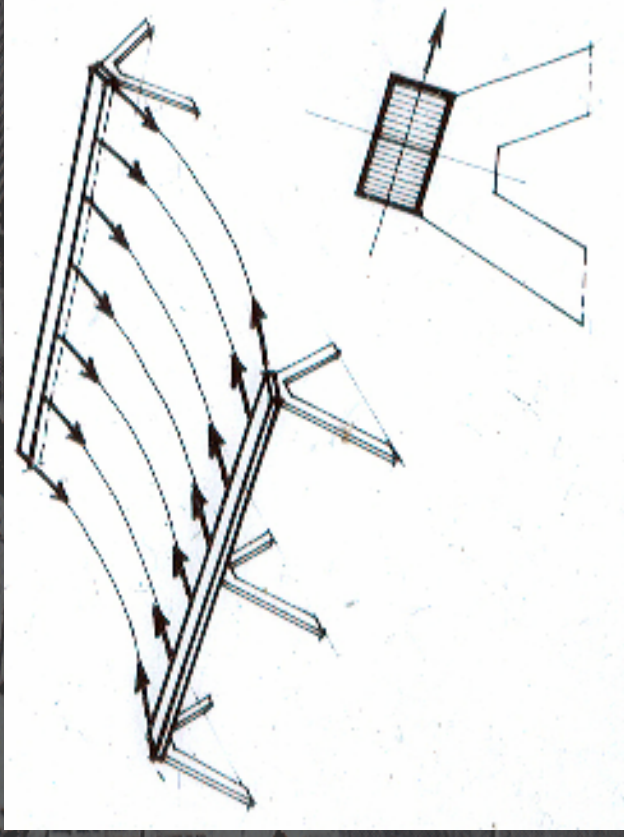
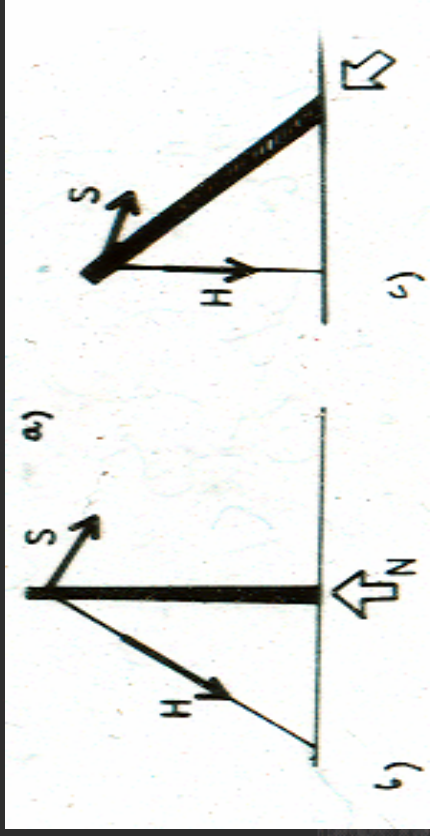
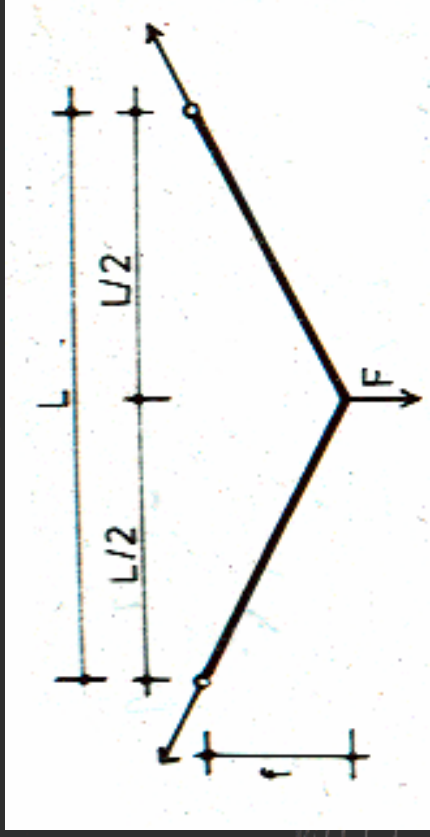

Támaszok kialakítása

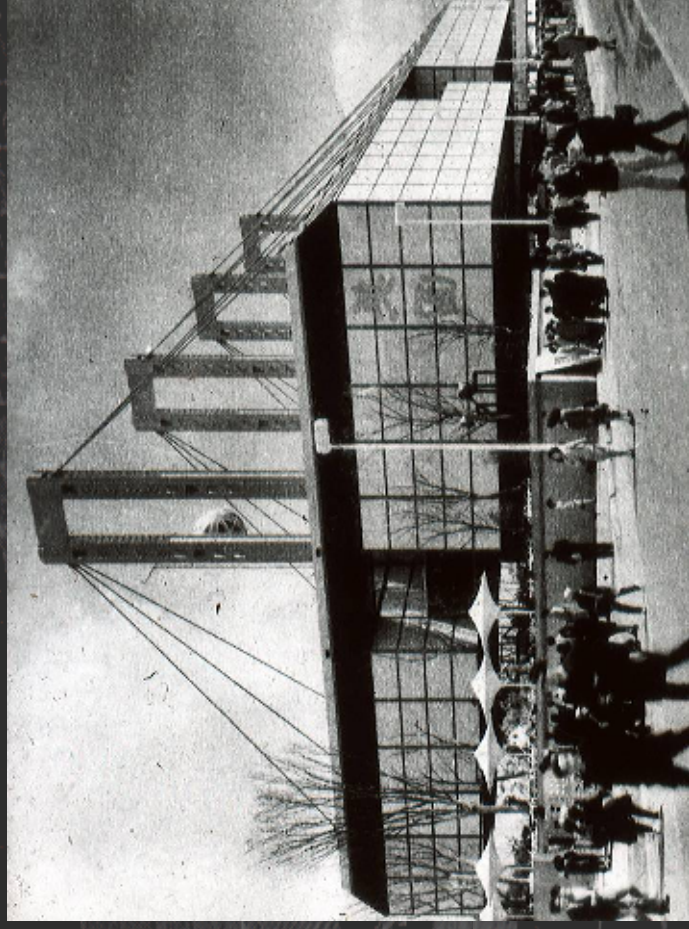

Támaszok kialakítása



Támaszok kialakítása

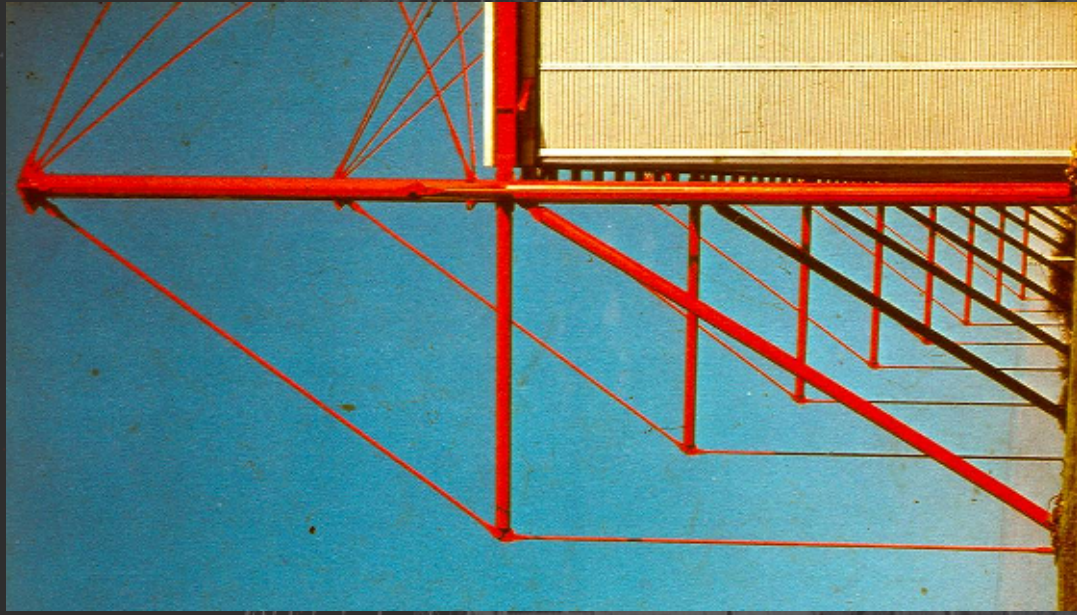

Támaszok kialakítása

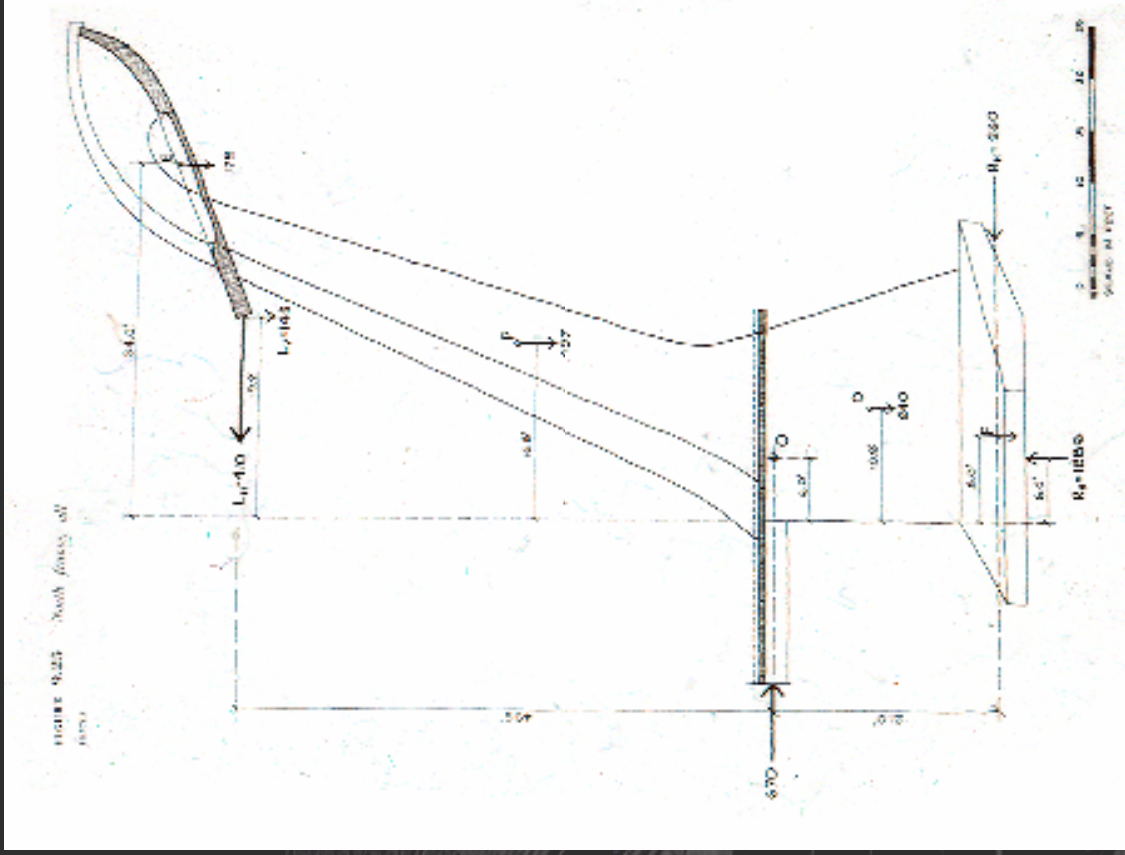
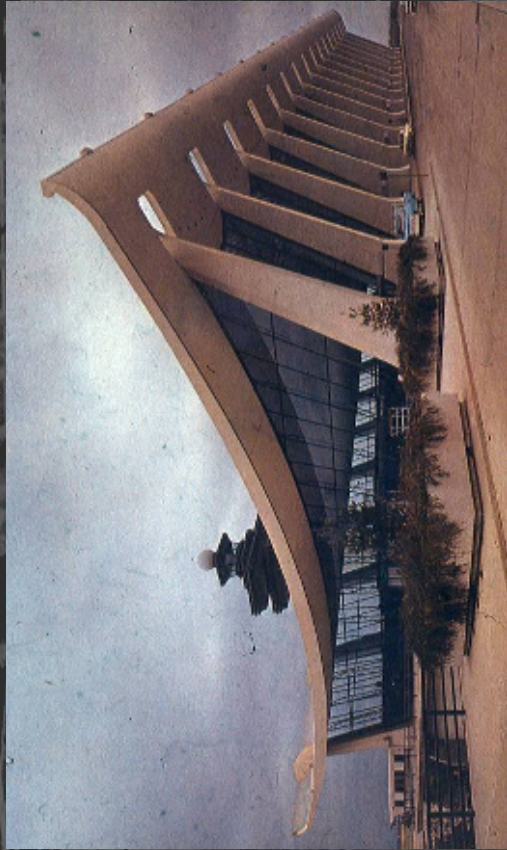
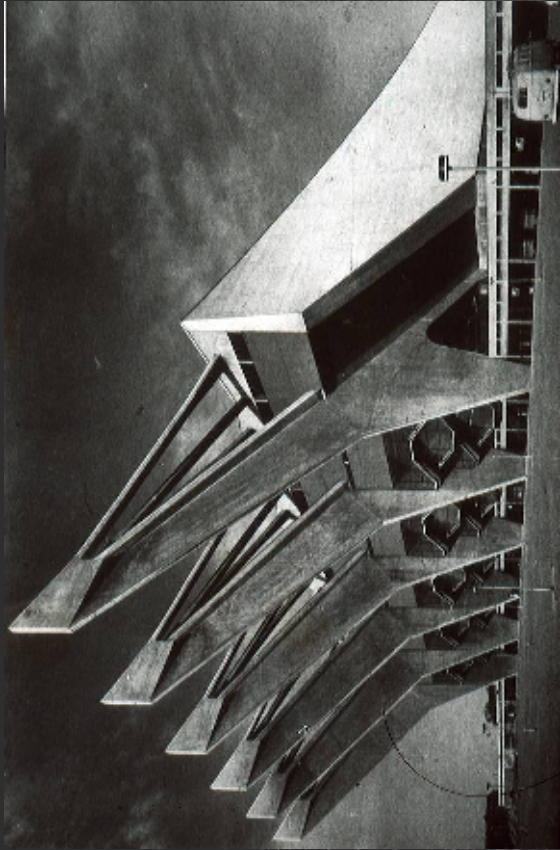

Burkolatok

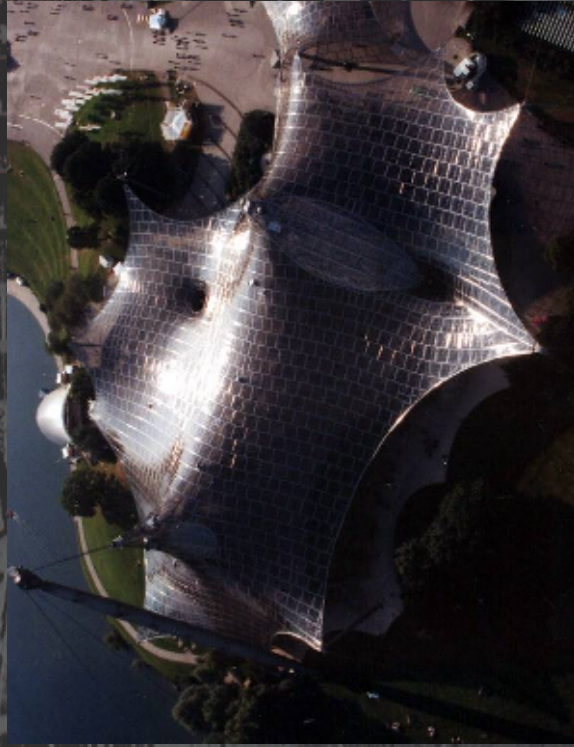
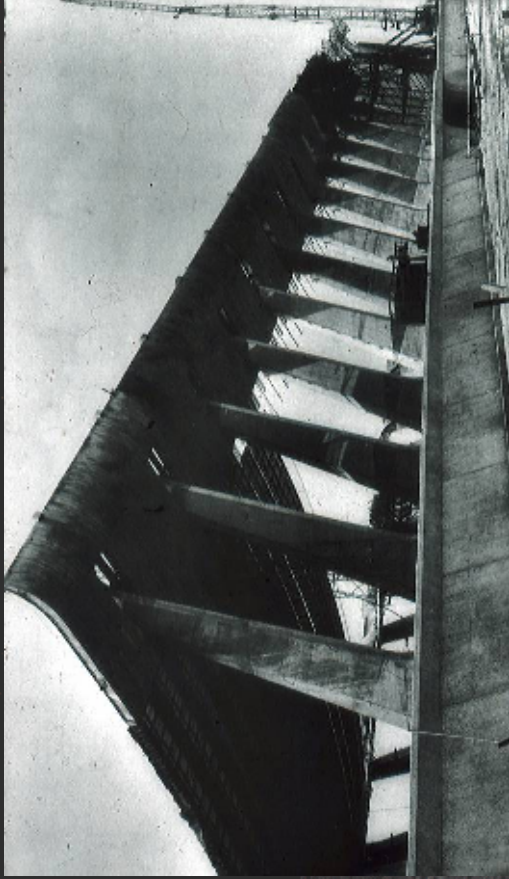
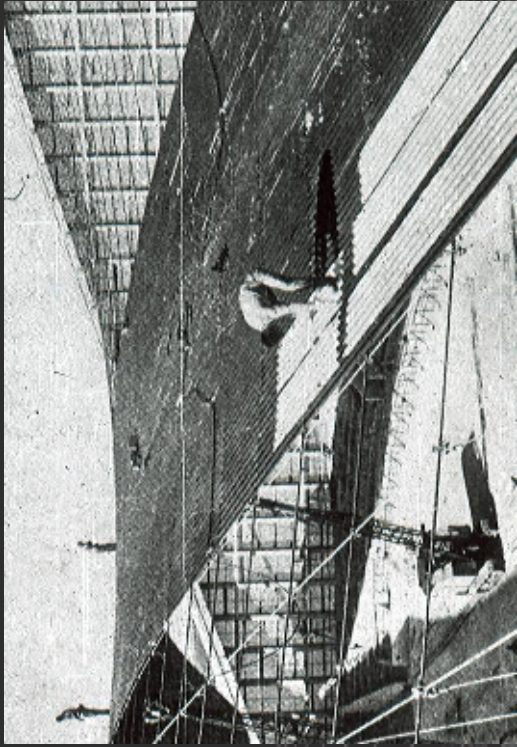

Burkolatok



Egyirányú szerkezetek

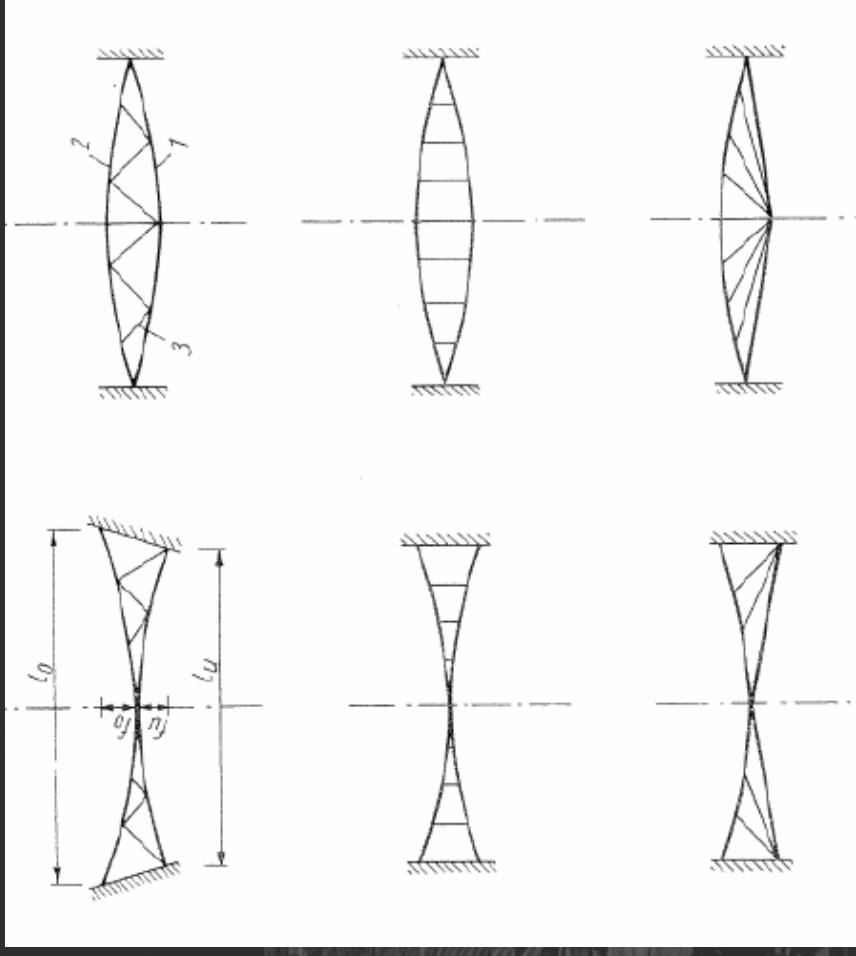
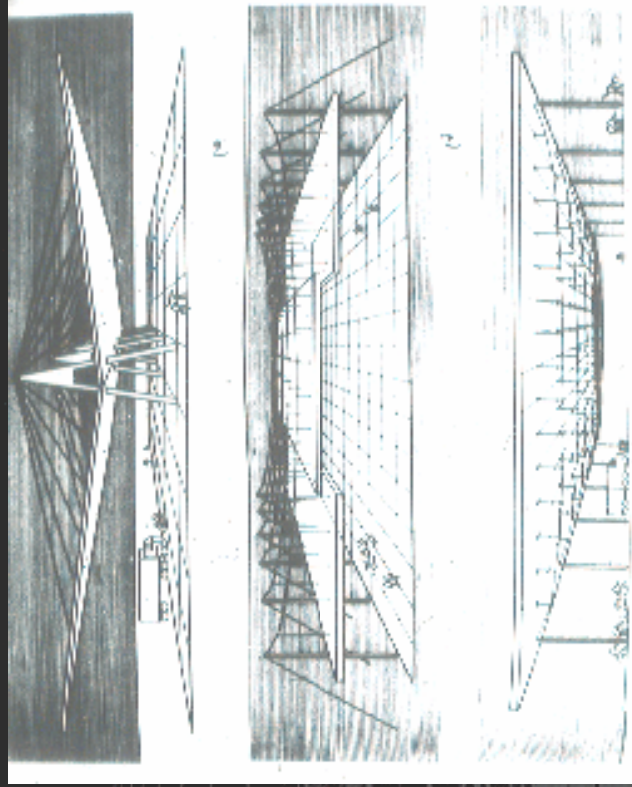

Egyirányú szerkezetek

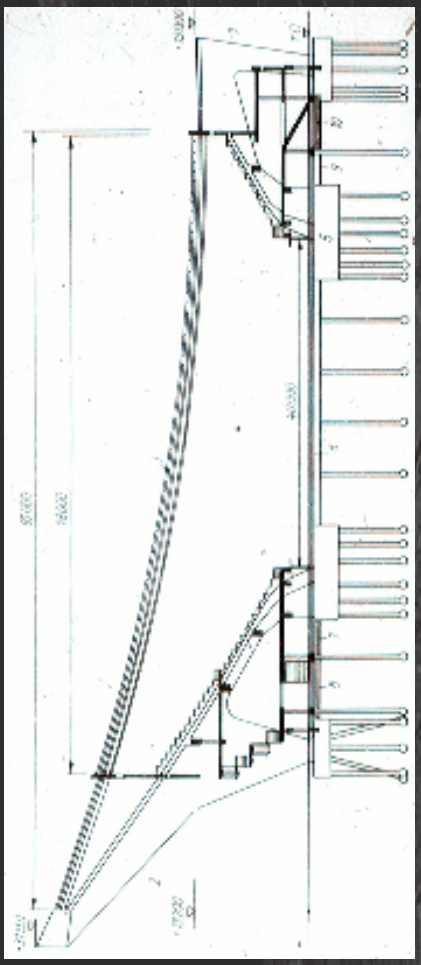

Egyirányú szerkezetek

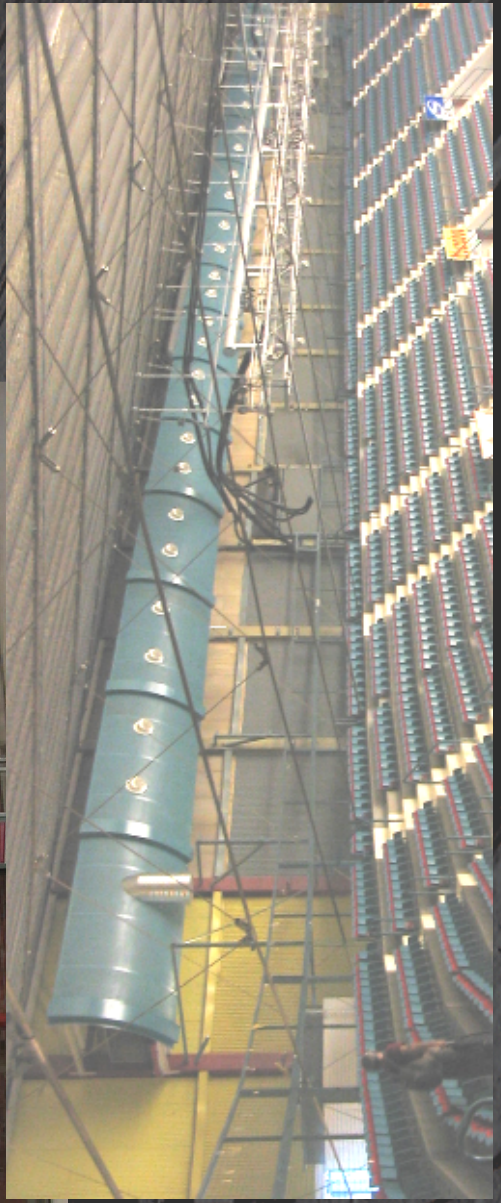

Egyirányú szerkezetek

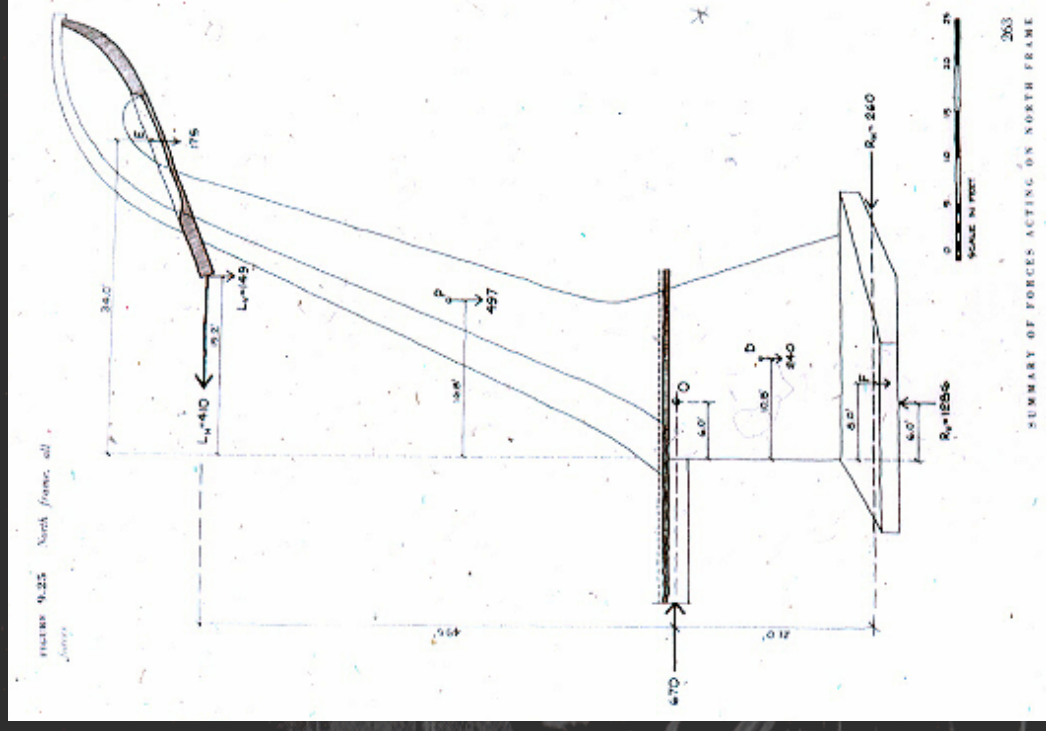
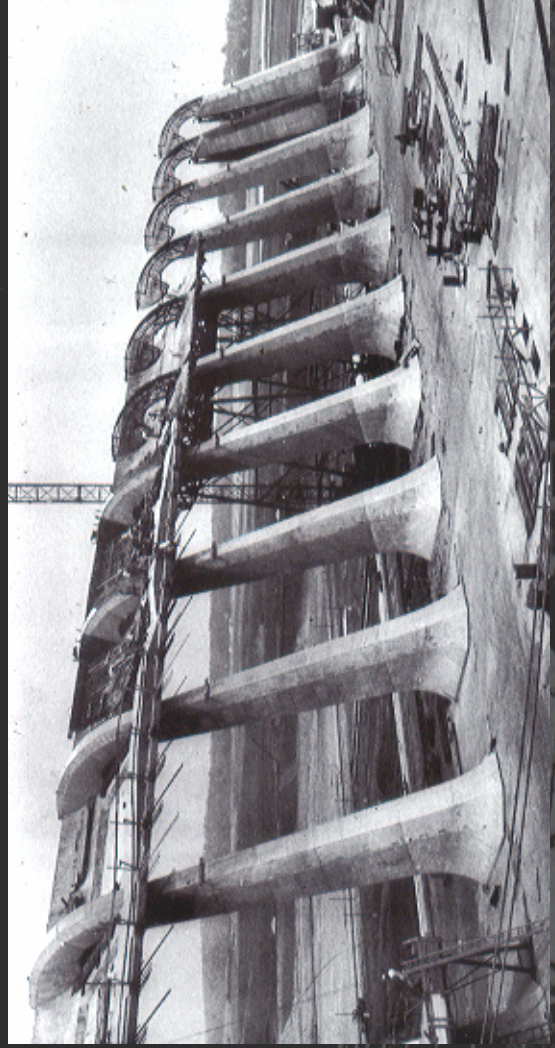

Egyirányú szerkezetek

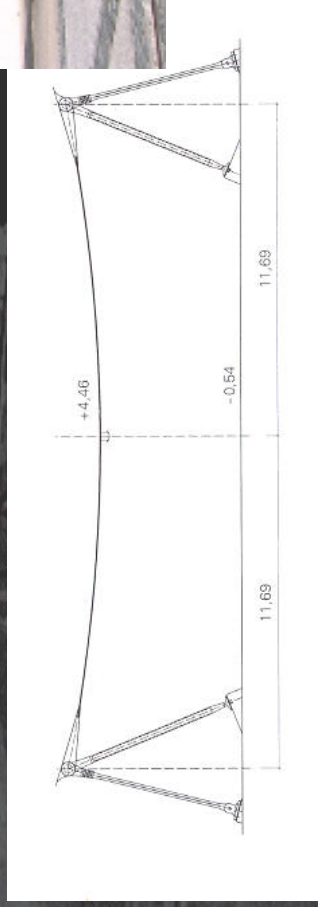

Küllős szerkezetek

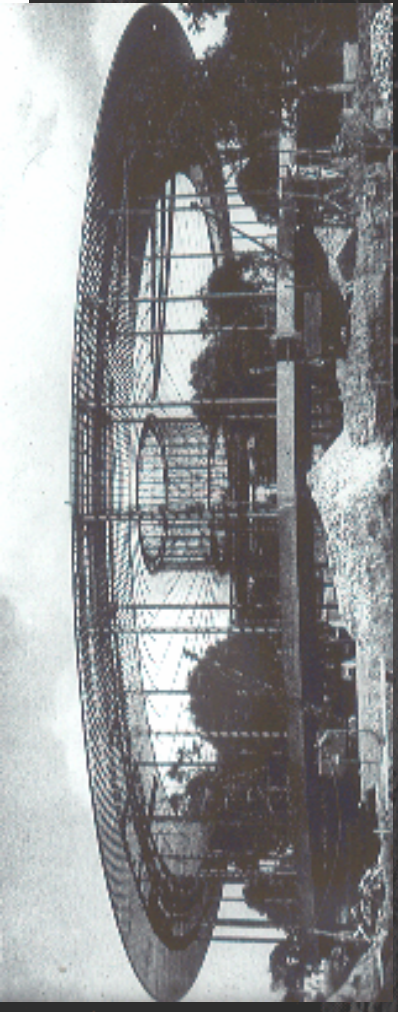
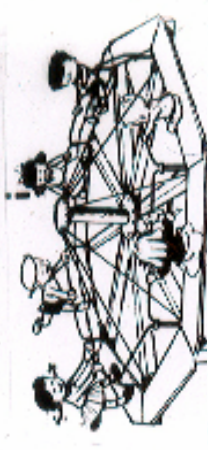

Kétszer görbült felületek

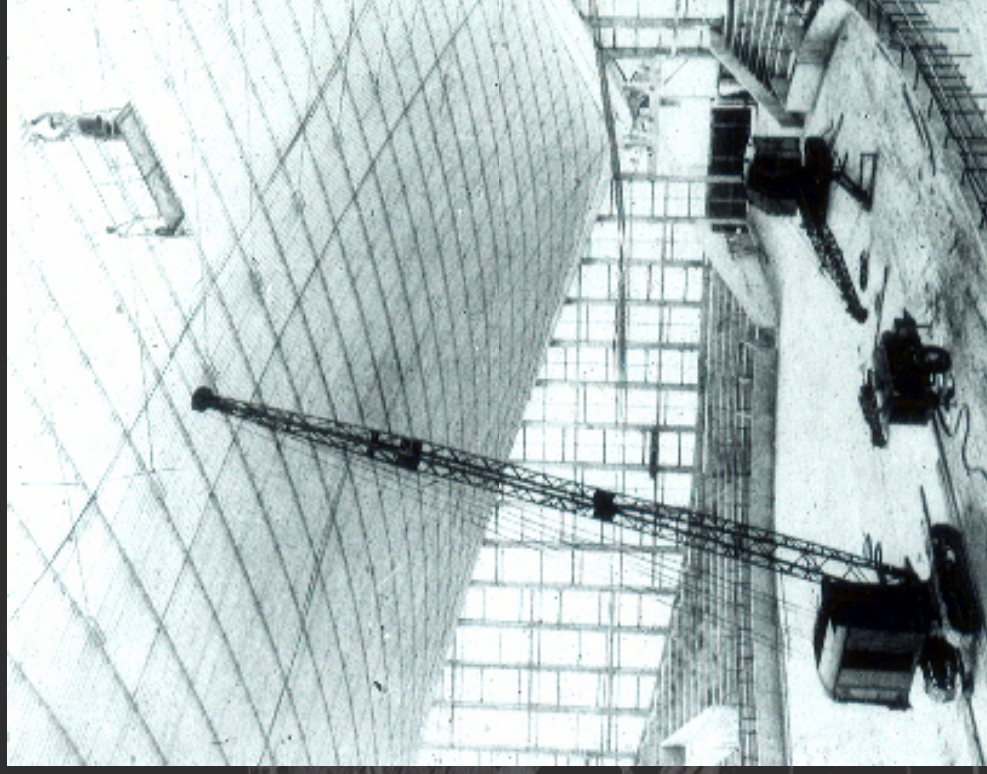
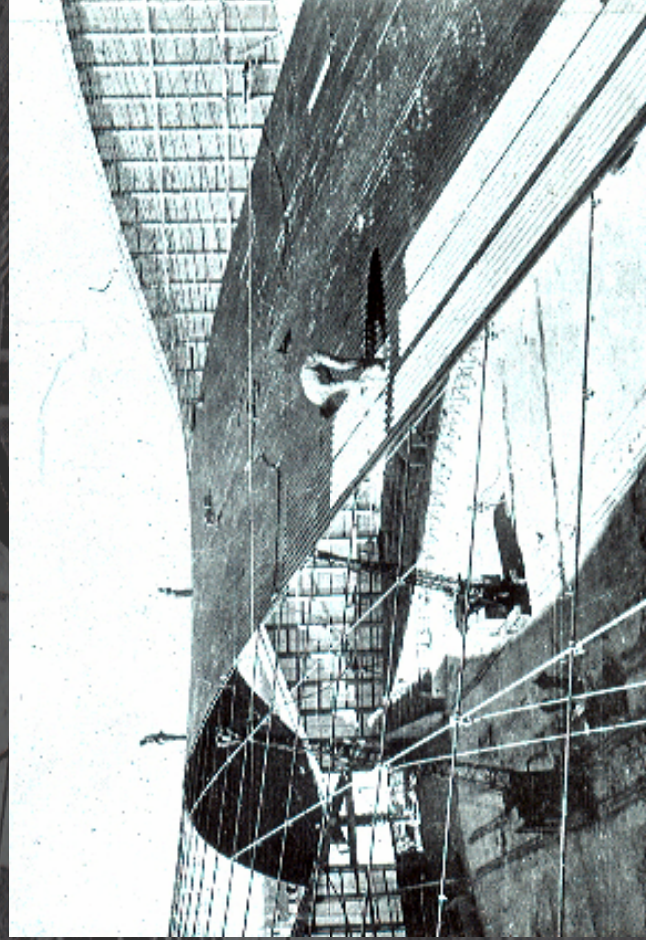
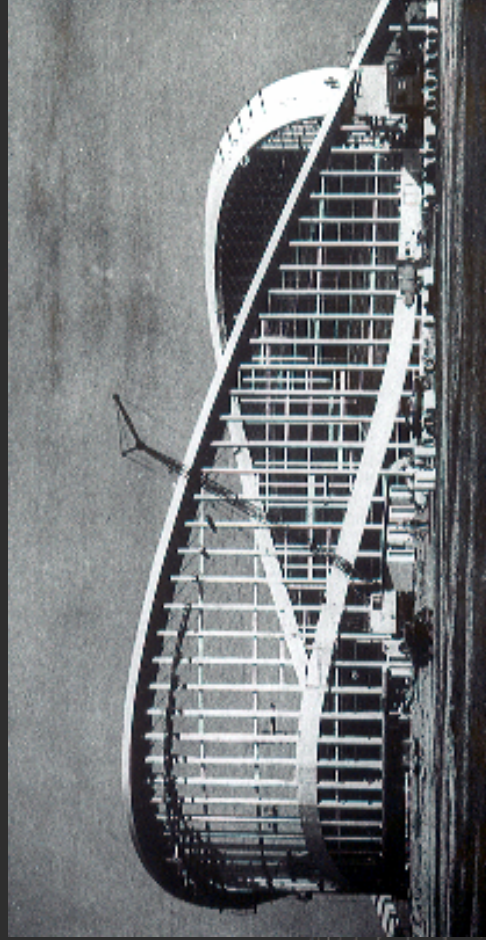

Kétszer görbült felületek

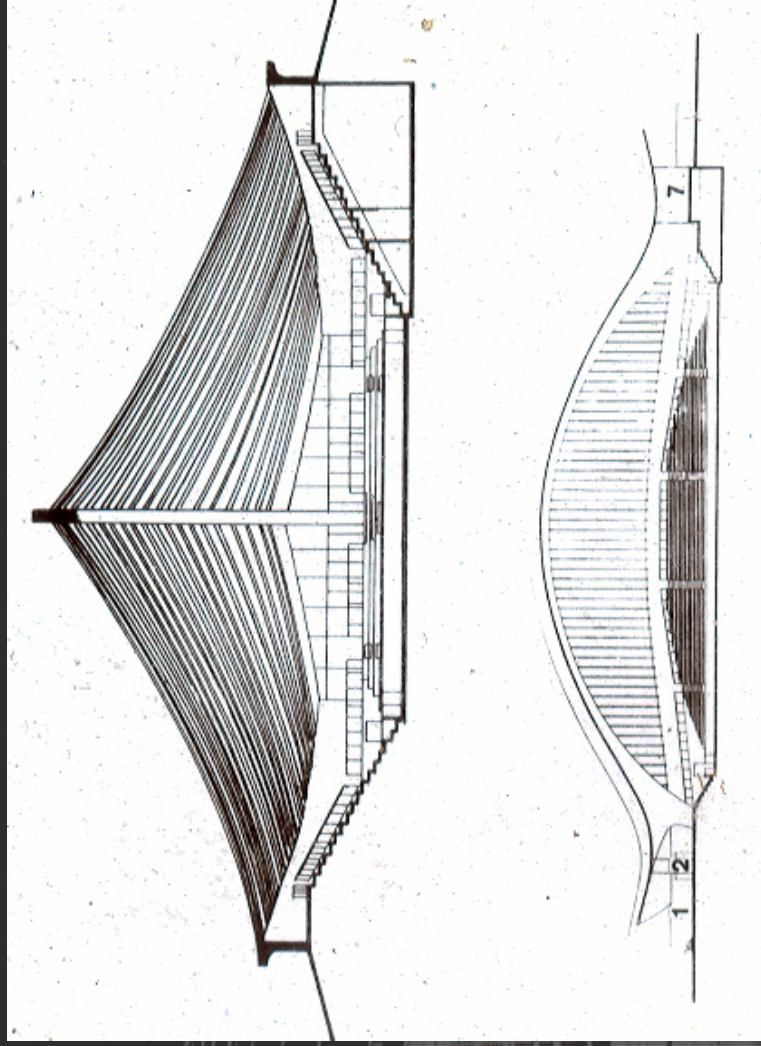

Kétszer görbült felületek

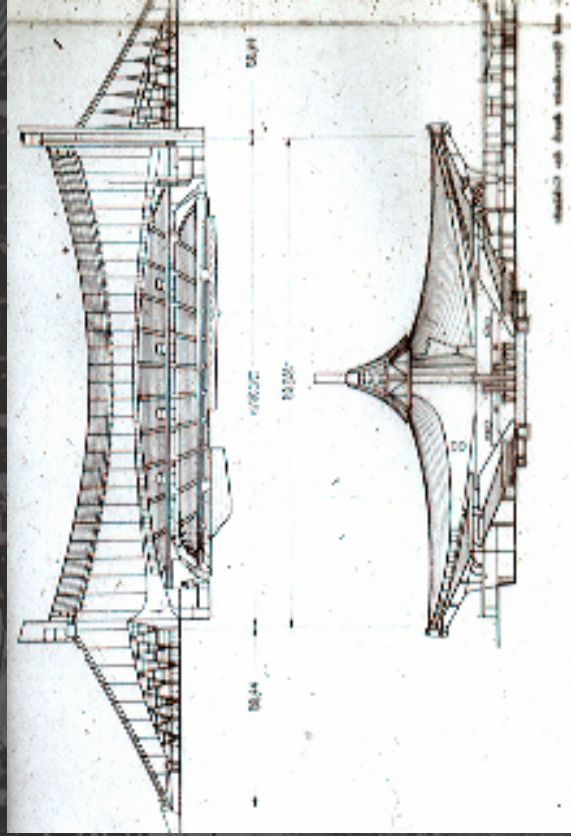
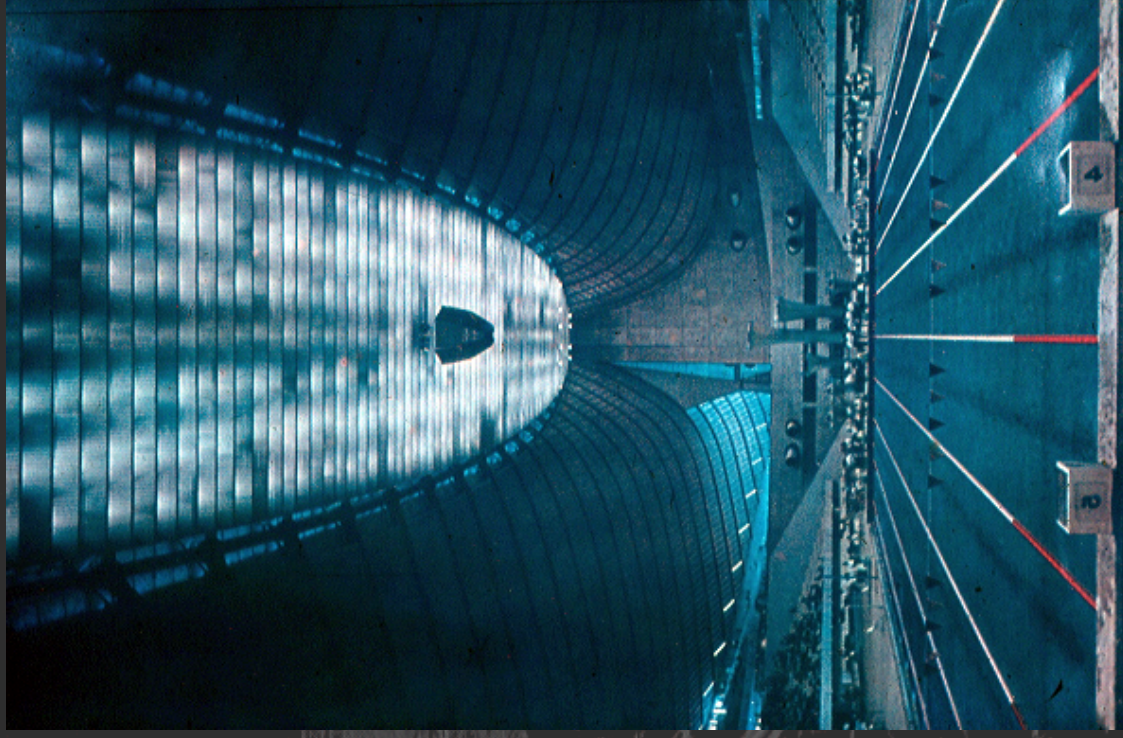

Kétszer görbült felületek

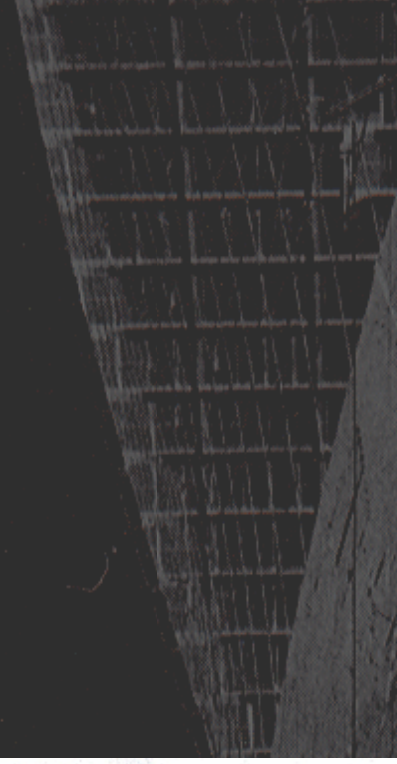
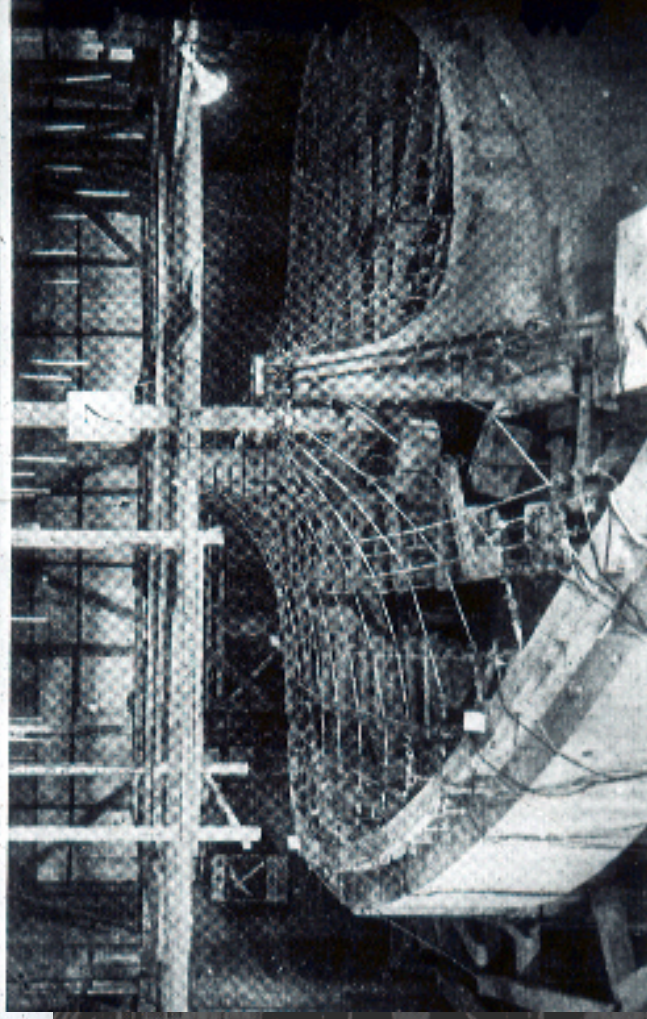
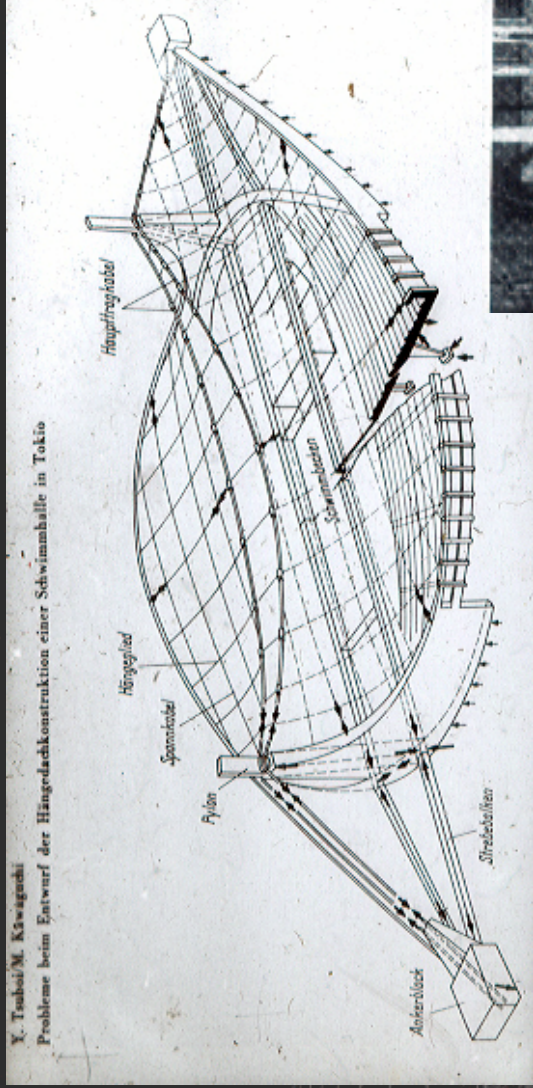

Kétszer görbült felületek

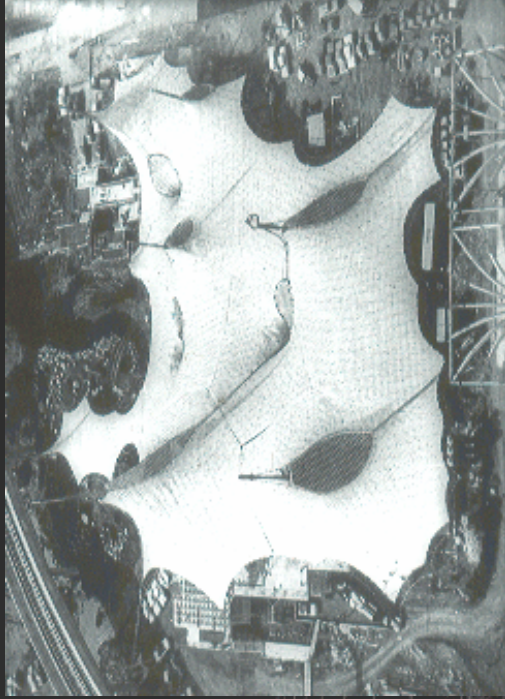

Kétszer görbült felületek

